

MANIACCESS



SCALA

4.10 m



80 VJR 105 VJR

7.90 m/10.30 m



78 XE 81 XE

7.80 m/8.10 m

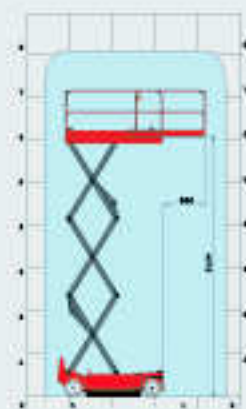

Model	SCALA	80 VJR	105 VJR	78 XE	81 XE
Type of platform	Vertical	Vertical		Scissors - electrical	
Platform capacity (SWL)	120 kg/1 person	200 kg/2 people*	200 kg/2 people	230 kg/2 people*	340 kg/2 people*
Working height (m)	-	7.90	10.30		
Rotation	4.10	350°	350°	7.80	8.10
Working offset (m)	-	3.30	3.30	1.50	
Overall length (m)	1.20	2.81	2.81	1.89	2.47
Overall height retracted (m)	1.75	1.99	1.99	2.11/1.76**	2.14/1.91**
Overall width (m)	0.73	0.99		0.81	
Control system	manual	Electro hydraulic proportional		Electro hydraulic proportional	
Power	electro pump 1.2 kw	24 v/180 Ah (CS)	24 v/270 Ah (CS)	24 v/180 Ah (C20)	24 v/180 Ah (C20)
Weight (kg)	180	2400	3280	1380	1700

* Only inside use

* Only inside use

** Guard-rail folded

**80 XEL
100 XEL
120 XEL**

8.00 m/12.20 m

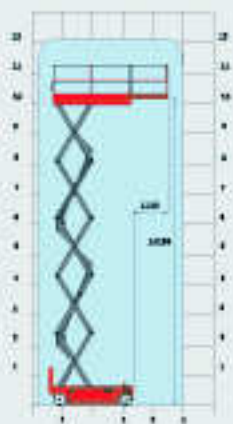

D 80 ER

8.00 m

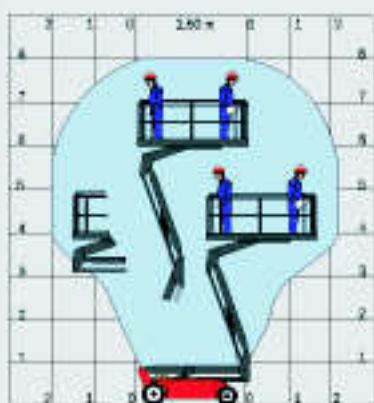

120 TH

12.20 m

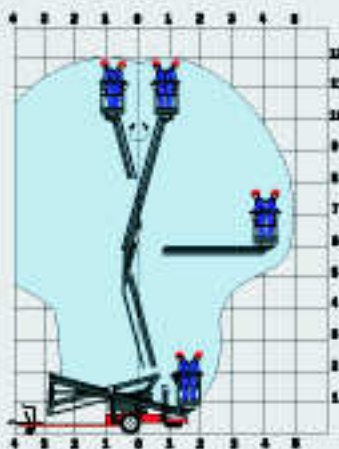

120 AE

12.10 m

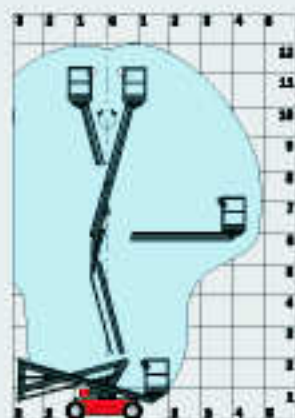

80 XEL	100 XEL	120 XEL	D 80 ER	120 TH	120 AE
Scissors - electrical			Electrical articulated platform	Articulated booms - towable	Electrical articulated booms
570/3 p.	450 kg/3 p.	320 kg/3p.	350 kg/2 people 160 kg/1 person (in-rotation)	250 kg/2 people	250 kg/2 people
8.00	10.20	12.20	8.00	12.20	12.10
	-		180°	350°	350°
1.70	1.70	1.70	2.69	4.90	4.96
2.80	2.80	2.80	2.50	5.90	4.93
2.25/1.51*	2.40/1.67*	2.56/1.81*	1.99	1.99	1.95
1.20	1.20	1.20	0.99	1.77	1.75
Electro hydraulic proportional			Electro hydraulic proportional	Electro hydraulic proportional	Electro hydraulic proportional
24 v/350 Ah (C20)			24 v/320 Ah	sector 220 v	24 v/300 Ah
2280	2500	2840	2320	1310	2910

* Guard-rail folded

120 AETJ 120 AETJ 3 D

11.95 m



150 AET

15.00 m



171 AET Double reach*

17.00 m



160 ATJ

16.25 m

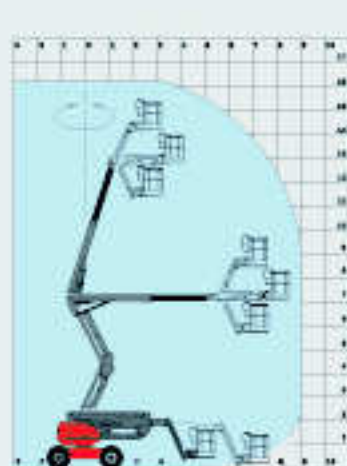
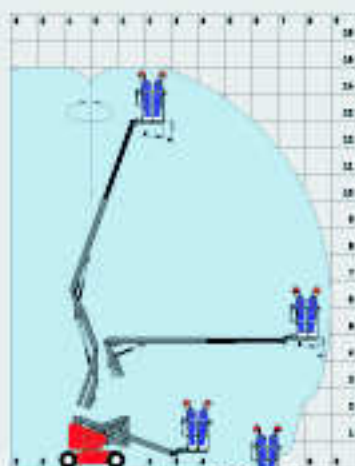
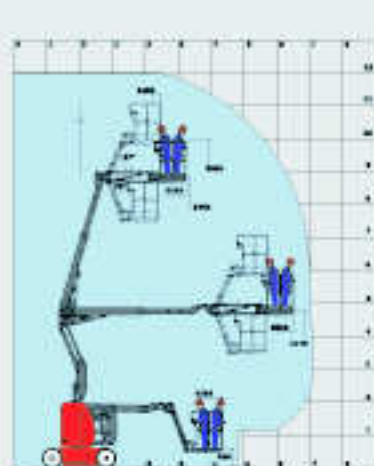

120 AETJ/120 AETJ 3 D		150 AET		171 AET Double reach*		160 ATJ	
Electrical articulated booms		Electrical articulated booms		Electrical articulated booms		Thermal articulated booms	
200 kg/2 people		230 kg/2 people		230 kg/2 people	150 kg/1 person	230 kg/2 people	
11.95		14.80		15.00	17.00	16.25	
350°		355°		355°	355°	350° (1)	
7.00		8.86		9.00	11.00	9.10	
5.48		5.75		6.46		7	
1.99		1.95		1.95		2.37	
1.20		1.50		1.50		2.30	
Electro hydraulic proportional		Electro hydraulic proportional		Electro hydraulic proportional		Electro hydraulic proportional	
48 v/300 Ah		48 v - 450 Ah		48 v - 450 Ah		Perkins 404C22 - 45 cv	
6550		7090		7500	7500	7450	

* 2 load charts on the same machine

(1) Oscillating steering axle
(2) Optional extra: continuous rotation

180 ATJ

17.70 m

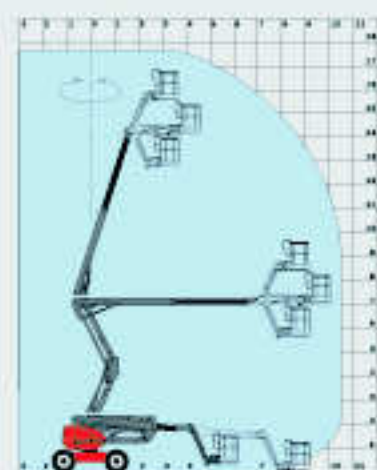

140 CT 230 CTJ

14.00 m/23.00 m

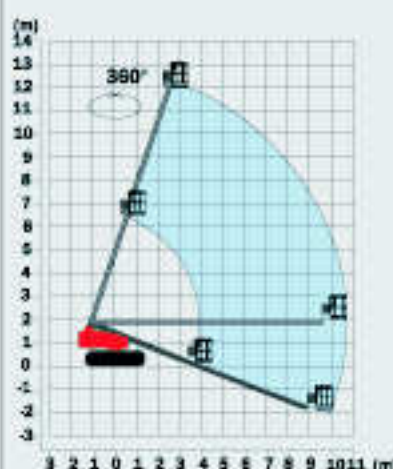

200 WT 200 WTJ/230 WTJ

20.20 m/23.00 m

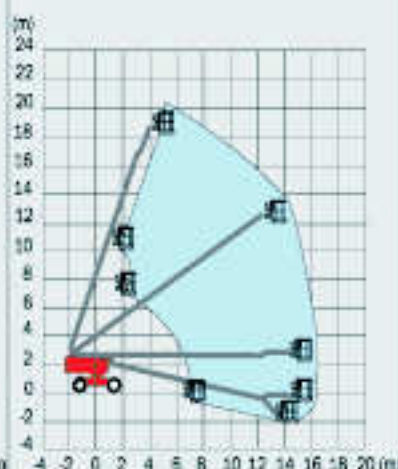

180 ATJ ⁽¹⁾	140 CT*	230 CTJ*	200 WT*	200 WTJ*	230 WTJ*	Model
Thermal articulated booms	Crawler telescopic		Wheeled telescopic			Type of platform
230 kg/2 people	250 kg/2 people	227 kg/2 people	227 kg/2 people			Platform capacity (SWL)
17,70	14,00	23,00	20,20	20,20	23,00	Working height (m)
350° ⁽²⁾	continuous		continuous	continuous	continuous	Rotation
10,60	11,10	18,30	17,20	16,30	18,30	Working offset (m)
7,77	6,33	11,57	9,17	10,40	11,57	Overall length (m)
2,37	2,20	2,35	2,64	2,64	2,64	Overall height retracted (m)
2,30	2,15	2,46	2,43	2,43	2,43	Overall width (m)
Electro hydraulic proportional	Electro hydraulic proportional		Electro hydraulic proportional			Control system
Perkins 404C22 - 45 cv	ISUZU 59 HP	ISUZU 59 HP	ISUZU 59 HP			Power
8090	7650	15200	12300	12300	14700	Weight (kg)

(1) Oscillating steering axle

(2) Optional extra: continuous rotation

* only available in several countries

* only available in several countries





Manitou, material handling world leader

Inventor of the rough terrain forklift truck, Manitou offers today the most comprehensive range to meet all specific handling and personal lifting requirements :

Telescopic trucks

MANISCOPIC

Rough terrain
and semi industrial
masted trucks

MANITOU

Access
equipment

MANIACCESS

Compact telescopic
handler

Twisto

Truck mounted forklifts

MANITRANSIT

Backhoe/Loader
with telescopic boom

MANILOADER

Swinging arm
and articulated
wheeled loaders

MANILOADER



A network of skilled professionals at your service

With a network of 500 service and parts centres in more than 100 countries, Manitou provides an efficient after-sales support based on the expertise of 2000 factory trained technicians.

The acquisition of this logo constitutes an offer and the company reserves the right to alter specifications without prior notice.
The MANITOU marks displayed in this brochure can be used exclusively with original equipment attachments.

CE

 **MANITOU**